

Reading Scales with Unmarked Scales

Write the temperature shown on each thermometer.

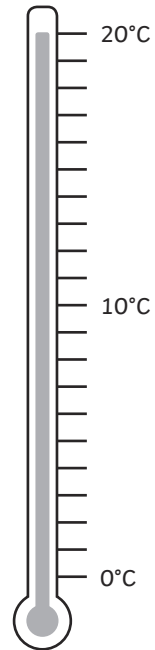

Write how much liquid is in each jug.

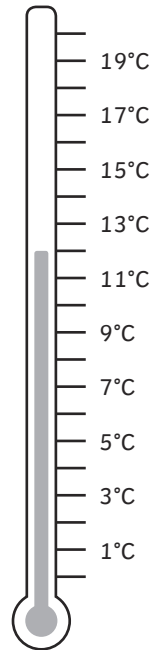
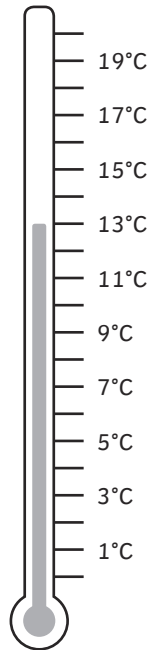
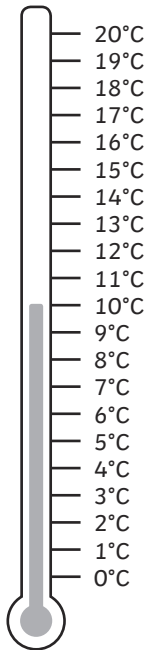
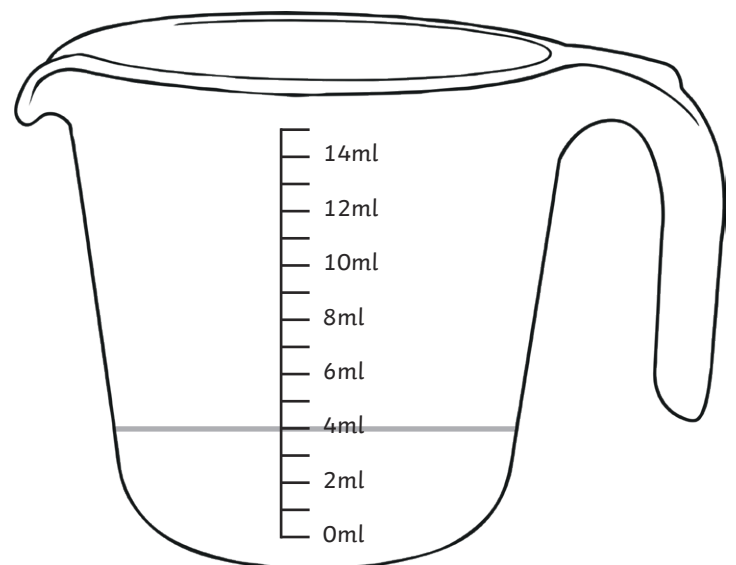
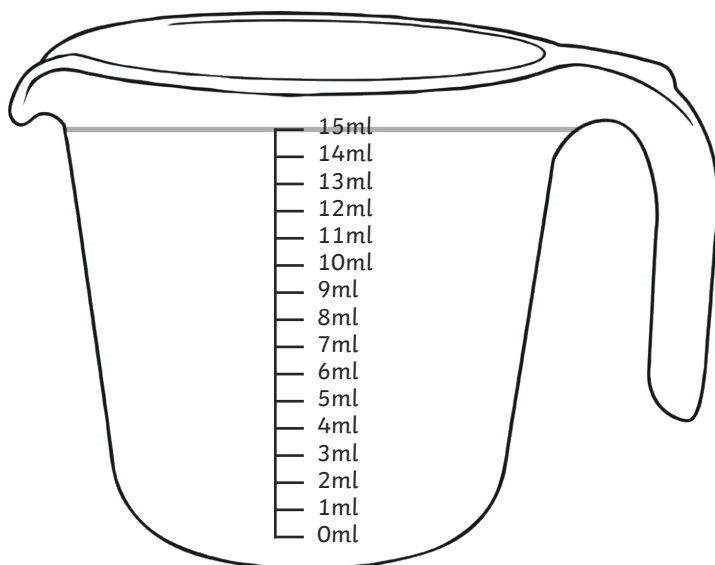

Reading Scales with Unmarked Scales

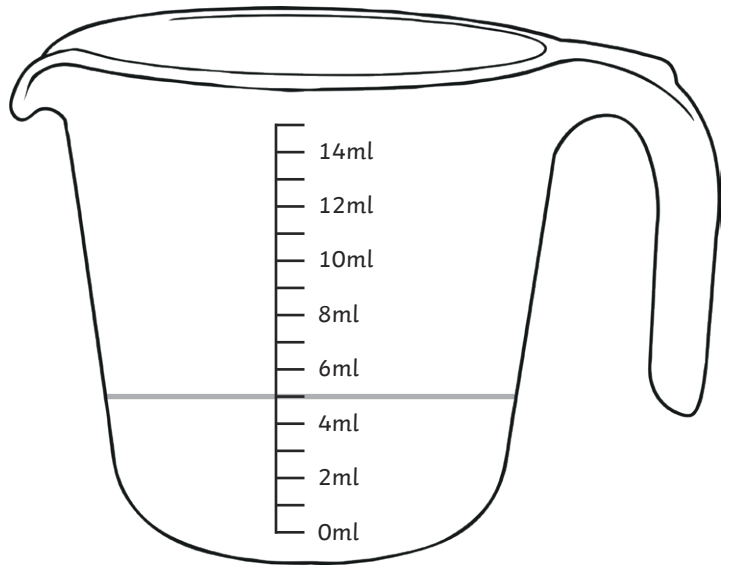
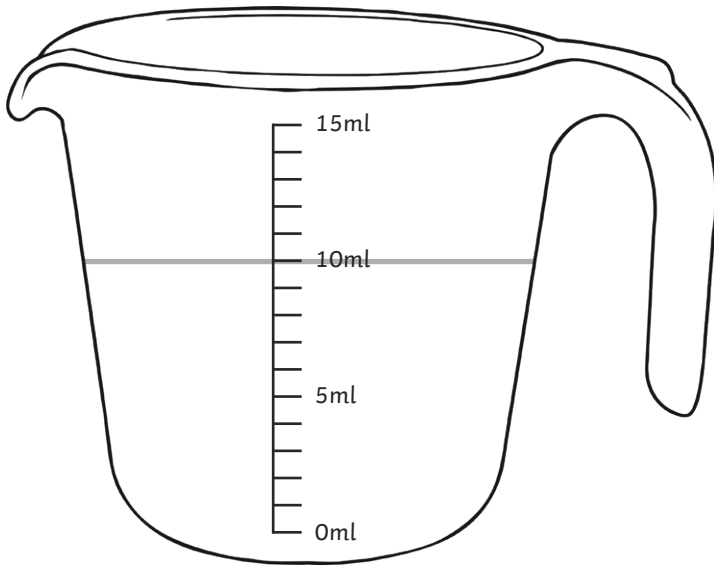

Write how much each parcel weighs.

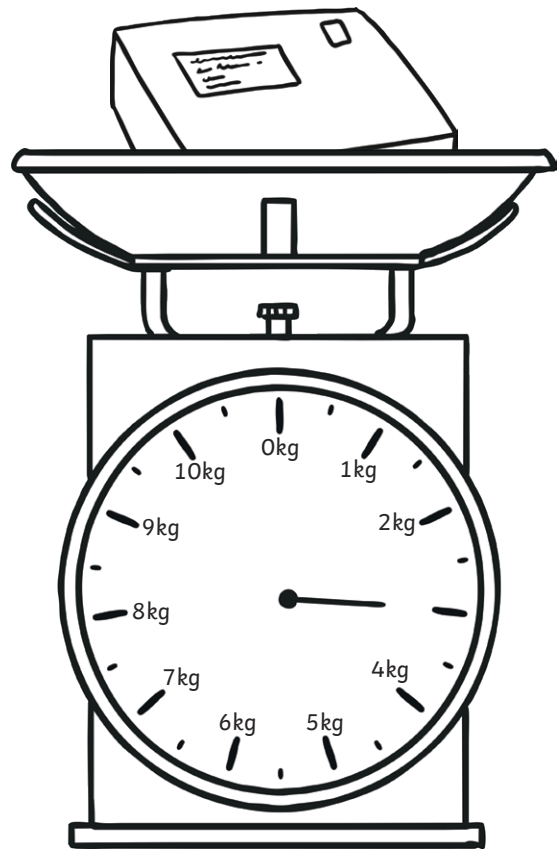
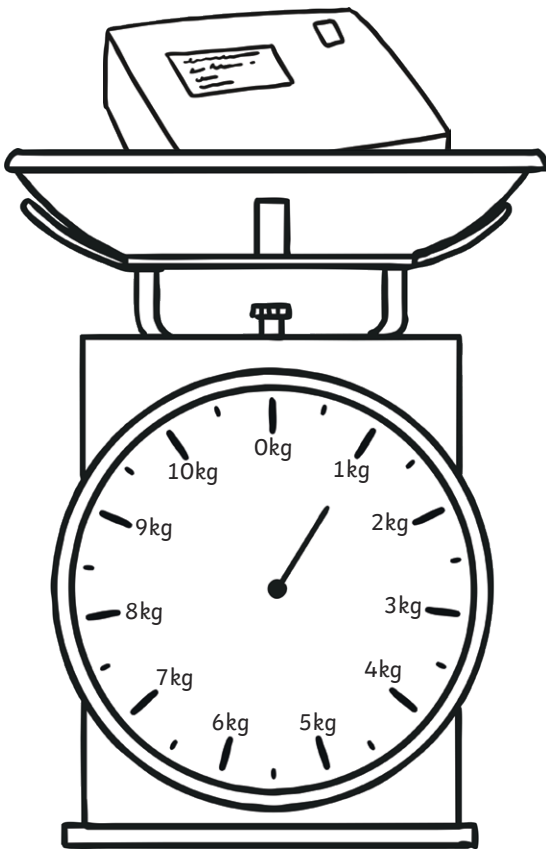

Reading Scales with Unmarked Scales

Write the temperature shown on each thermometer.

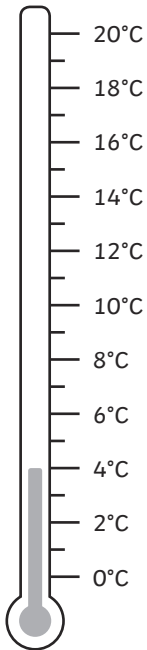

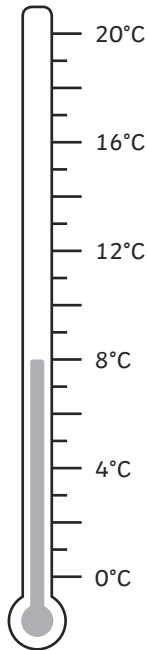

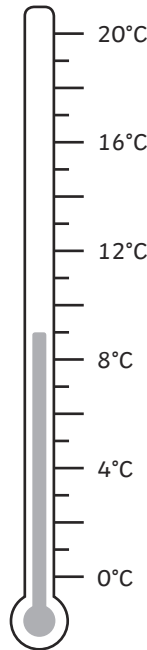

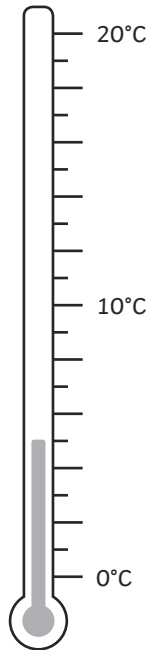

Write how much liquid is in each jug.

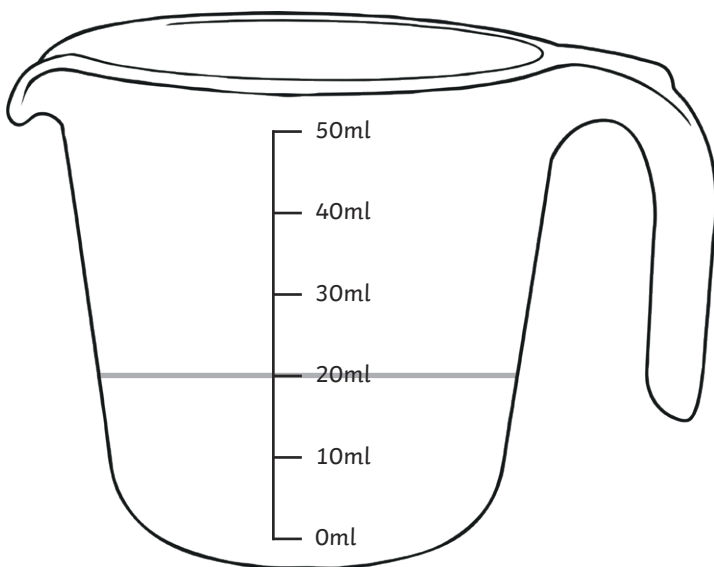

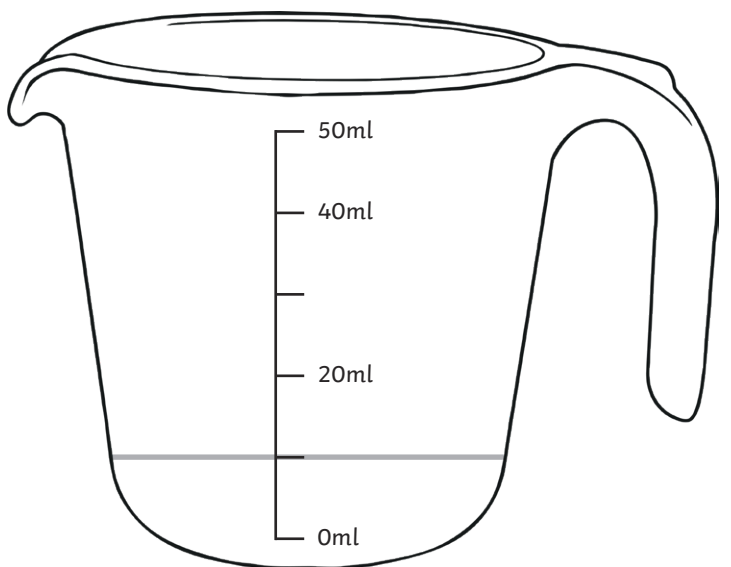

Reading Scales with Unmarked Scales

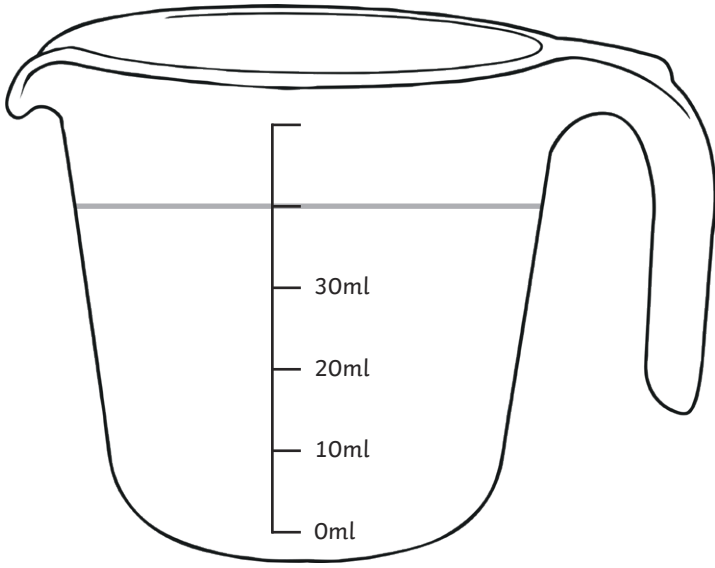

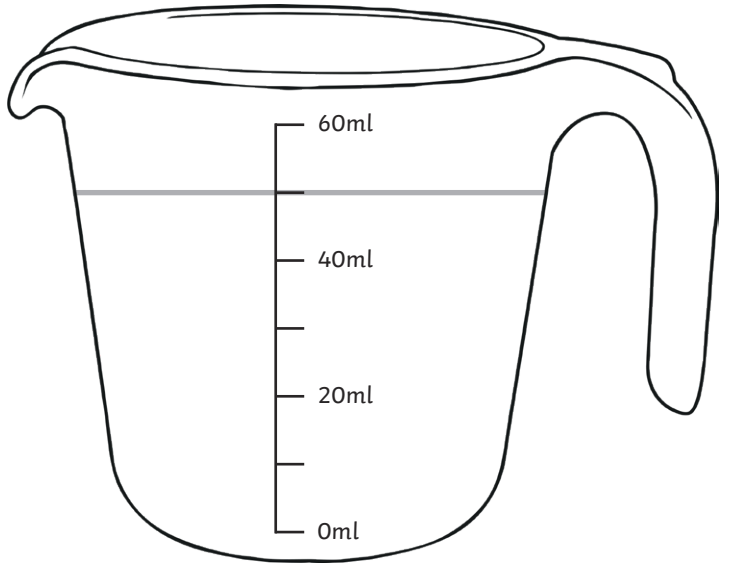

Write how much each parcel weighs.

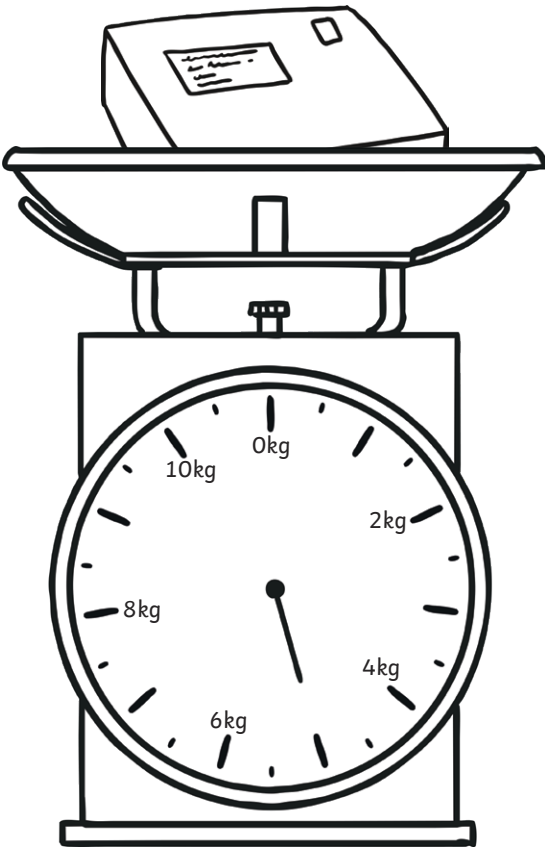

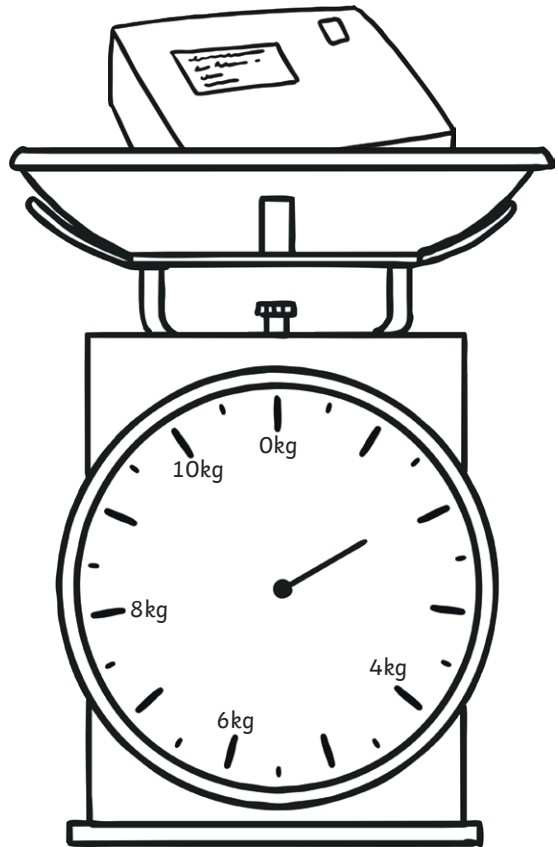

Reading Scales with Unmarked Scales

Write the temperature shown on each thermometer.

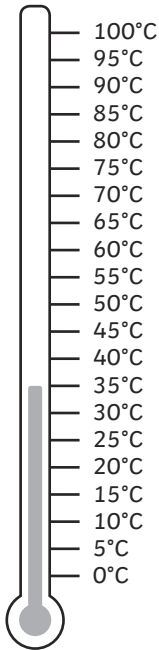

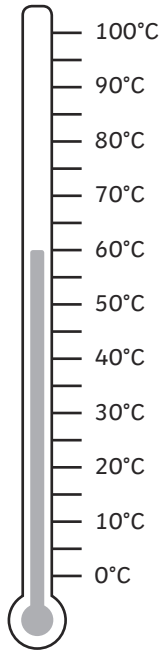

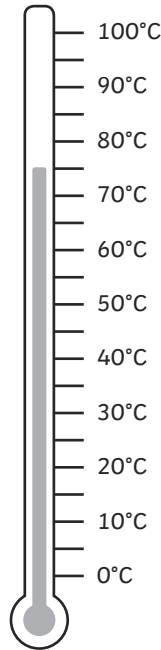

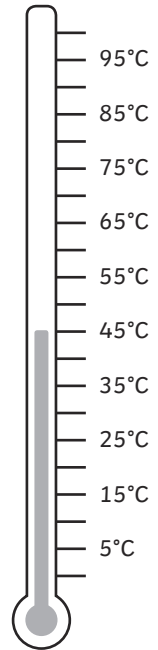

Write how much liquid is in each jug.

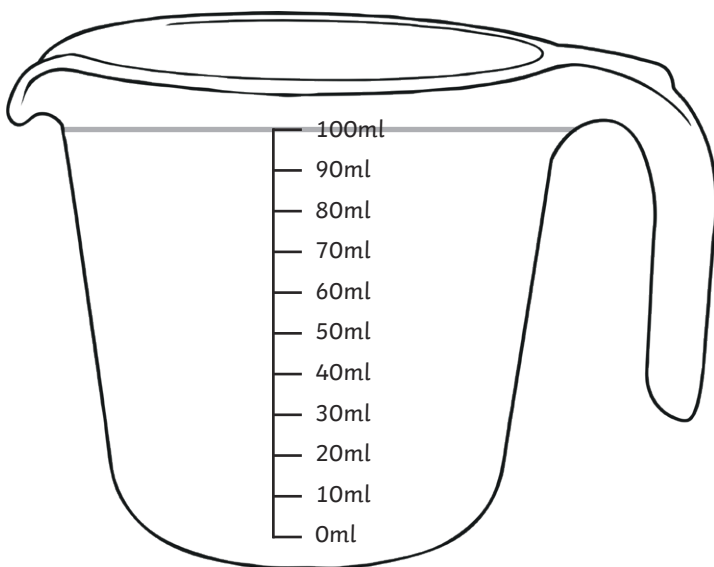

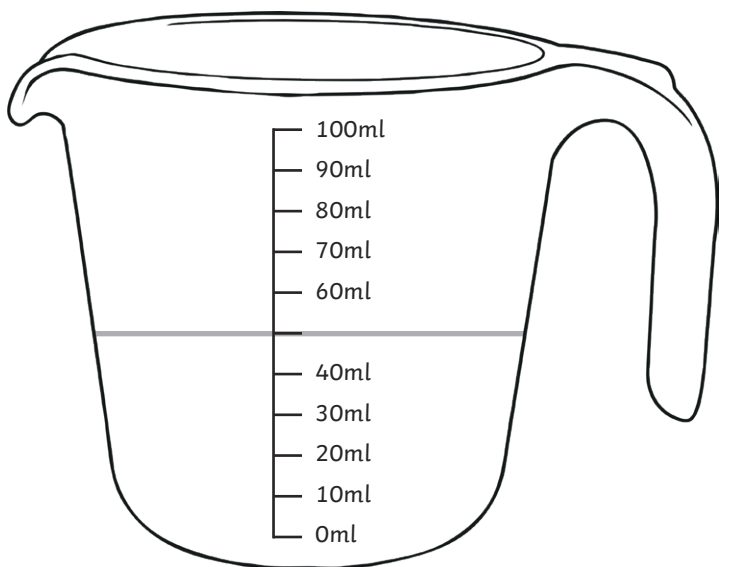

Reading Scales with Unmarked Scales

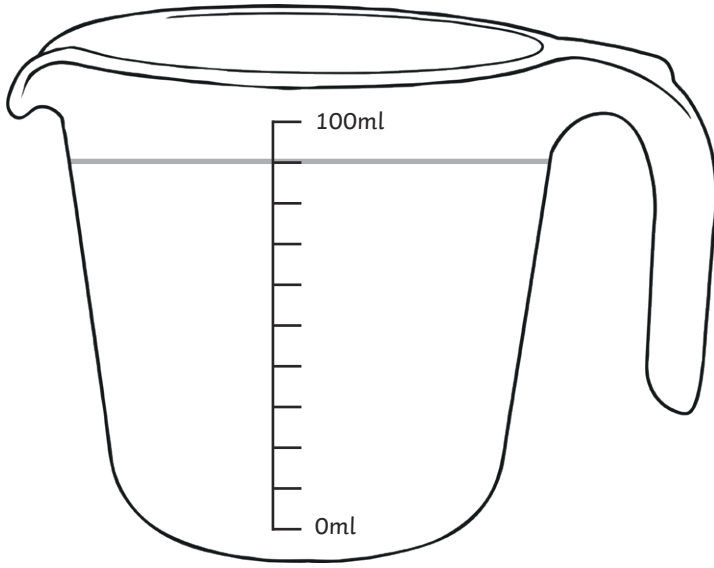

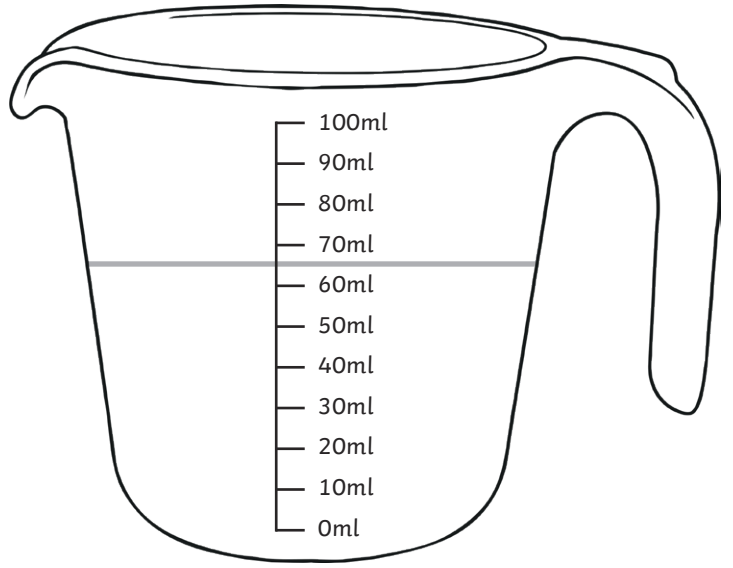

Write how much each parcel weighs.

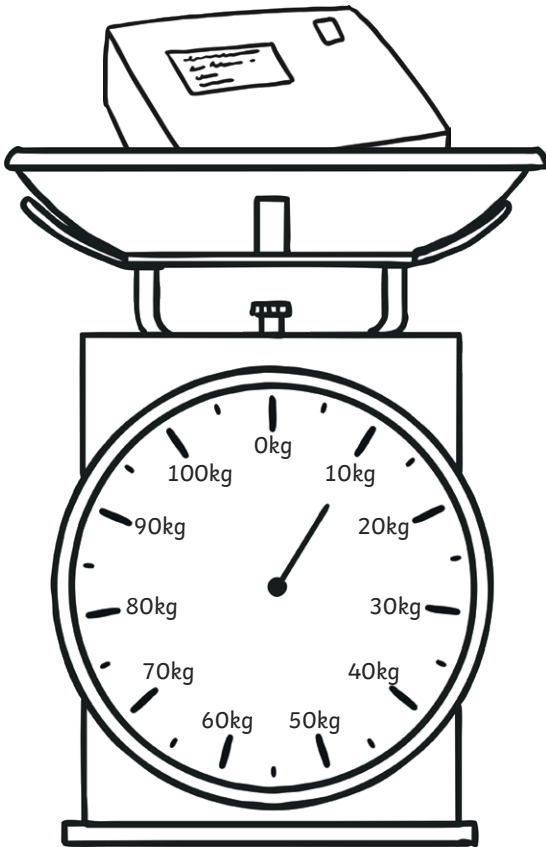

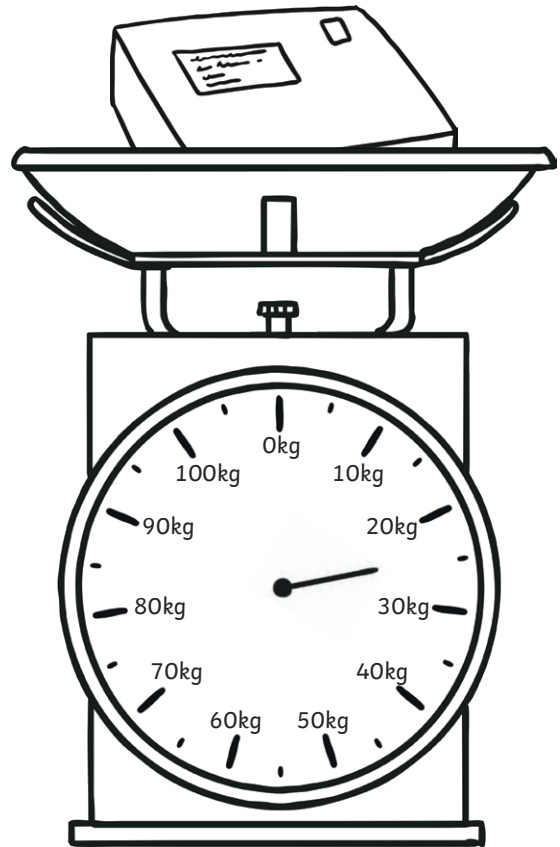

Reading Scales with Unmarked Scales **Answers**

★

Write the temperature shown on each thermometer.

1. 10°C 2. 13°C 3. 12°C 4. 20°C

Write how much liquid is in each jug.

1. 15ml 2. 4ml 3. 10ml 4. 5ml

Write how much each parcel weighs.

1. 1kg 2. 3kg

★★

Write the temperature shown on each thermometer.

1. 4°C 2. 8°C 3. 9°C 4. 5°C

Write how much liquid is in each jug.

1. 20ml 2. 10ml 3. 40ml 4. 50ml

Write how much each parcel weighs.

1. 5kg 2. 2kg

★★★

Write the temperature shown on each thermometer.

1. 35°C 2. 60°C 3. 75°C 4. 45°C

Write how much liquid is in each jug.

1. 100ml 2. 50ml 3. 90ml 4. 65ml

Write how much each parcel weighs.

1. 10kg 2. 25kg